

Purpose

The RT7232 is a high-performance 650kHz 4A step down regulator with an internal power switch and synchronous rectifier. This document explains the function and use of the RT7232 evaluation board (EVB) and provides information to enable operation and modification of the evaluation board and circuit to suit individual requirements.

Table of Contents

| | |
|--|-------------|
| <i>Purpose</i> | 1 |
| <i>Introduction</i> | 2 |
| <i>General Product Information</i> | 2 |
| <i>Key Performance Summary Table</i> | 3 |
| <i>Bench Test Setup Conditions</i> | 4 |
| <i>Headers Description and Placement</i> | 4 |
| <i>Test Points</i> | 5 |
| <i>Power-up & Measurement Procedure</i> | 5 |
| <i>Output Voltage Setting</i> | 5 |
| <i>Schematic, Bill of Materials and Board Layout</i> | 6 |
| <i>EVB Schematic Diagram</i> | 6 |
| <i>Bill of Materials</i> | 7 |
| <i>EVB Layout</i> | 8 |
| <i>Other Technical Information</i> | 錯誤! 尚未定義書籤。 |

Introduction

General Product Information

General Description

The RT7232 is a high-performance 650kHz 4A step down regulator with an internal power switch and synchronous rectifier. It features quick transient response using its Advanced Constant On-Time (ACOT™) control architecture that provides stable operation with small ceramic output capacitors and without complicated external compensation, among other benefits. The input voltage range is from 4.5V to 18V and the output is adjustable from 0.765V to 8V.

The proprietary ACOT™ control improves upon other fast response constant on-time architectures, achieving nearly constant switching frequency over line, load, and output voltage ranges. Since there is no internal clock, response to transients is nearly instantaneous and inductor current can ramp quickly to maintain output regulation without large bulk output capacitance. The RT7232 is stable with and optimized for ceramic output capacitors.

With its internal 90mΩ switch and 60mΩ synchronous rectifier, the RT7232 displays excellent efficiency and good behavior across a range of applications, especially for low output voltages and low duty cycles. Cycle-by cycle current limit, input under-voltage lock-out, externally-adjustable soft-start, output under- and overvoltage protection, and thermal shutdown provide safe and smooth operation in all operating conditions.

The RT7232 evaluation board uses the RT7232GQW IC in a WDFN-10L3x3 package with an exposed thermal pad. The IC is also available in a PTSSOP-14 package with an exposed thermal pad.

Features

- Fast Transient Response
- Steady 650kHz Switching Frequency at PWM
- 4A Output Current
- Advanced Constant On-Time (ACOT™) Control
- Optimized for Ceramic Output Capacitors
- 4.5V to 18V Input Voltage Range
- Internal 90mΩ Switch and 60mΩ Synchronous Rectifier
- 0.765V to 8V Adjustable Output Voltage
- Externally-adjustable, Pre-biased Compatible Soft-Start
- Cycle-by-Cycle Current Limit
- Output Over- and Under-voltage Shut-down

Key Performance Summary Table

| Key features | Evaluation board number: PCB002_V1 |
|--------------------------------|--|
| Default Input voltage | 12V |
| Max Output Current | 4A |
| Default Output Voltage | 1.05V |
| Default Marking & Package Type | RT7232GQW (WDFN-10L 3x3) |
| Operation Frequency | Steady 650kHz at PWM |
| Other Key Features | Advanced constant On-time(ACOT™) control Power Good Adjustable Soft-start (external capacitor) PSM/ PWM Auto Switched |
| Protection | Over current protection: Cycle-by-Cycle Current Limit Hiccup Mode Output Over- and Under-voltage Shut-down |

Bench Test Setup Conditions

Headers Description and Placement

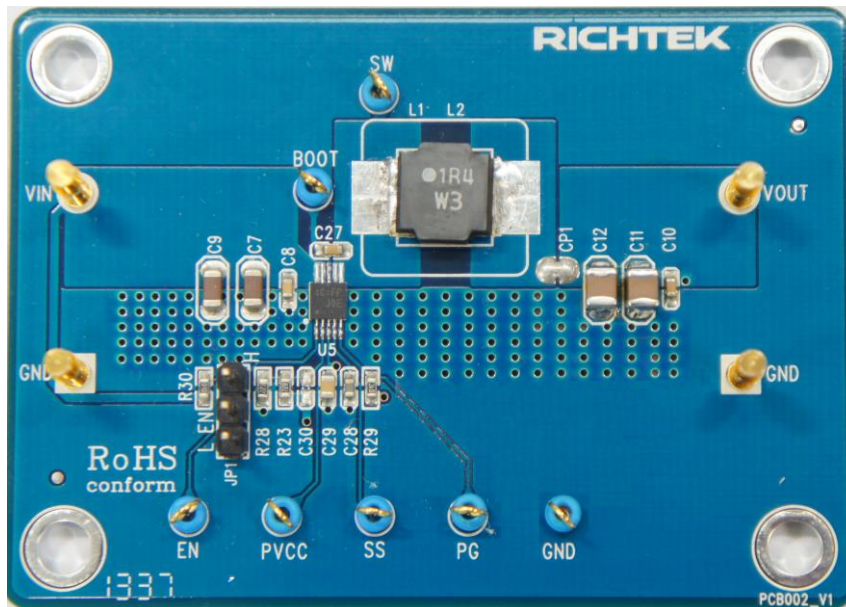

Please carefully inspect the EVB IC and external components, comparing them to the following Bill of Materials, to ensure that all components are installed and undamaged. If any components are missing or damaged during transportation, please contact the distributor or send e-mail to evb_service@richtek.com.

Test Points

The EVB is provided with the test points and pin names listed in the table below.

| Test point/ Pin name | Signal | Comment (expected waveforms or voltage levels on test points) |
|-------------------------|------------------------------------|--|
| VIN | Input voltage | Input voltage range = 4.5V to 18V |
| VOUT | Output voltage | Default output voltage = 1.05V Output voltage range = 0.765V to 8V (see " Output Voltage Setting" section for changing output voltage level) |
| GND | Ground | Ground reference for the input voltage, output voltage and analog ground |
| SW | Switching node test point | SW waveform |
| EN | Enable test point | Enable signal. Drive EN or install a shorting block on Jumper JP1 to enable operation (shorting 2-3) or disable operation (shorting 1-2). |
| JP1 | Chip enable control | Install jumper or drive EN directly to enable or disable operation |
| BOOT | Boot strap supply test point | Floating supply voltage for the high-side N-MOSFET switch |
| SS | Soft-start control test point | Soft start waveform |
| PVCC | Linear regulator output test point | Internal linear regulator output= 5.1V |
| PG | Power good output test point | Connected to PVCC through R29, PG voltage is 5.1V when soft-start is complete and the output voltage is in regulation |

Power-up & Measurement Procedure

1. Connect a jumper at JP1 terminals 1 and 2, connecting EN to GND, to disable operation.
2. Apply a 12V nominal input power supply ($4.5V < V_{IN} < 18V$) to the VIN and GND terminals.
3. Set the jumper at JP1 to connect terminals 2 and 3, connecting EN to VIN through resistor R30, to enable operation.
4. Verify the output voltage (approximately 1.05V) between VOUT and GND.
5. Connect an external load up to 4A to the VOUT and GND terminals and verify the output voltage and current.

Output Voltage Setting

Set the output voltage with the resistive divider (R23, R28) between VOUT and GND with the midpoint at FB. The output is set by the following formula:

$$V_{OUT} = 0.765 \times \left(1 + \frac{R23}{R28}\right)$$

The installed V_{OUT} capacitors (C11, C12) are 22 μ F, 16V X5R ceramic types. Do not exceed their operating voltage range and consider their voltage coefficient (capacitance vs. bias voltage) and ensure that the capacitance is sufficient to maintain stability and provide sufficient transient response for your application. Installing a small 5pF to 22pF capacitor at C30 (in parallel with R23) may be desirable to improve transient response for higher output voltages. See the RT7232 IC datasheet for more information.

Schematic, Bill of Materials and Board Layout

EVB Schematic Diagram

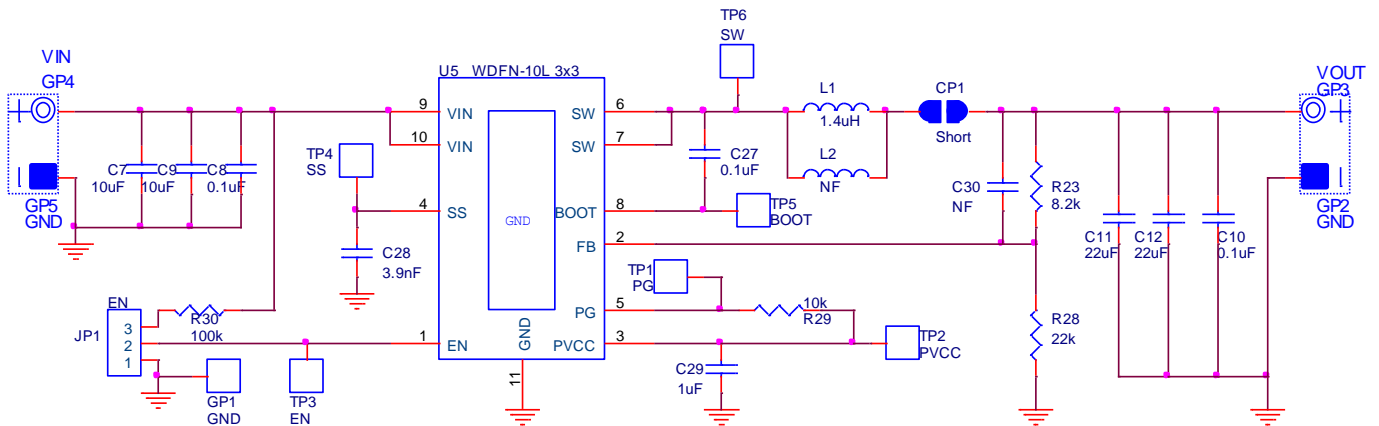

C7, C9: 10 μ F/50V/X5R, 1206, TDK C3216X5R1H106K

C11, C12: 22 μ F/16V/X5R, 1210, Murata GRM32ER61C226K

L1: 1.4 μ H TAIYO YUDEN NR8040T1R4N, DCR=7m Ω

Bill of Materials

| Reference | Qty | Part number | Description | Package | Manufacture |
|---------------|-----|---------------------|--|--------------|-------------|
| U5 | 1 | RT7232GQW | DC/DC Converter | WDFN-10L 3x3 | Richtek |
| C7,C9 | 2 | C3216X5R1H106K160AB | 10 μ F/ \pm 10%/50V/X5R Ceramic Capacitor | 1206 | TDK |
| C11,C12 | 2 | GRM32ER61C226KE20# | 22 μ F/ \pm 10%/16V/X5R Ceramic Capacitor | 1210 | Murata |
| C28 | 1 | 0603B392K500 | 3.9nF/ \pm 10%/50V/X7R Ceramic Capacitor | 0603 | WALSIN |
| C8,C10,C27 | 3 | C1608X7R1H104K080AA | 0.1 μ F/ \pm 10%/50V/X7R Ceramic Capacitor | 0603 | TDK |
| C29 | 1 | C1608X5R1E105K080AC | 1 μ F/ \pm 10%/25V/X5R Ceramic Capacitor | 0603 | TDK |
| C30 | 0 | | Not Installed | 0603 | |
| L1 | 1 | NR8040T1R4N | 1.4 μ H/7A/ \pm 30%, DCR=7m Ω , Inductor | 8mmx8mmx4mm | TAIYO YUDEN |
| L2 | 0 | | Not Installed | | |
| R28 | 1 | | 22k/ \pm 5%, Resistor | 0603 | |
| R23 | 1 | | 8.2k/ \pm 5%, Resistor | 0603 | |
| R29 | 1 | | 10k/ \pm 5%, Resistor | 0603 | |
| R30 | 1 | | 100k/ \pm 5%, Resistor | 0603 | |
| CP1 | 1 | | 0 (Short) | | |
| JP1 | 1 | | 3-Pin Header | | |
| TP1/2/3/4/5/6 | 6 | | Test Pin | | |
| GP | 5 | | Golden Pin | | |

EVB Layout

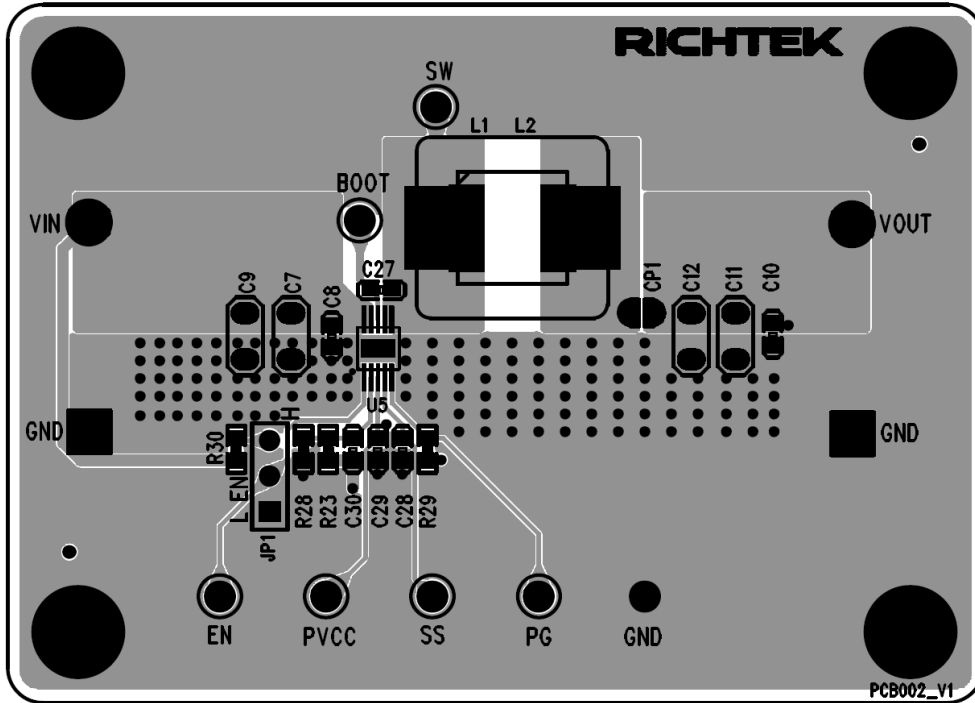

Top View (1st layer)

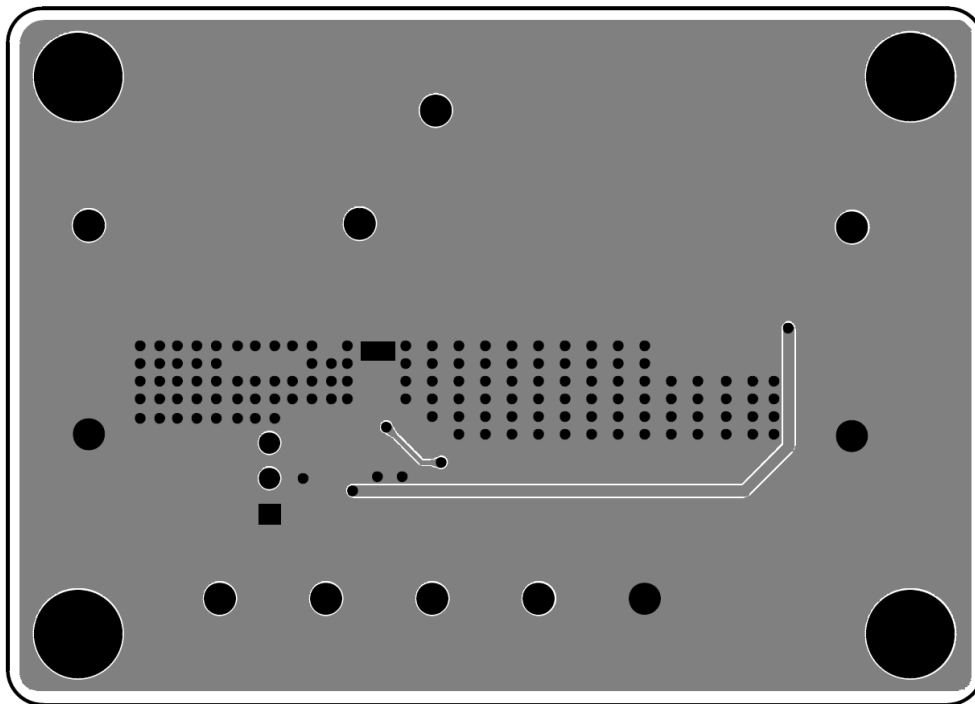

Bottom View (4th Layer)

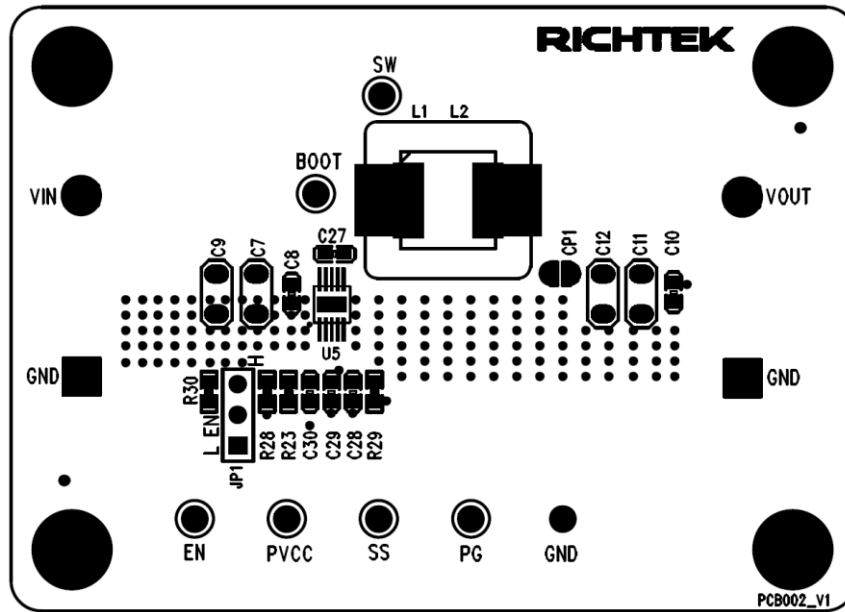

Component Placement Guide—Component Side (1st layer)

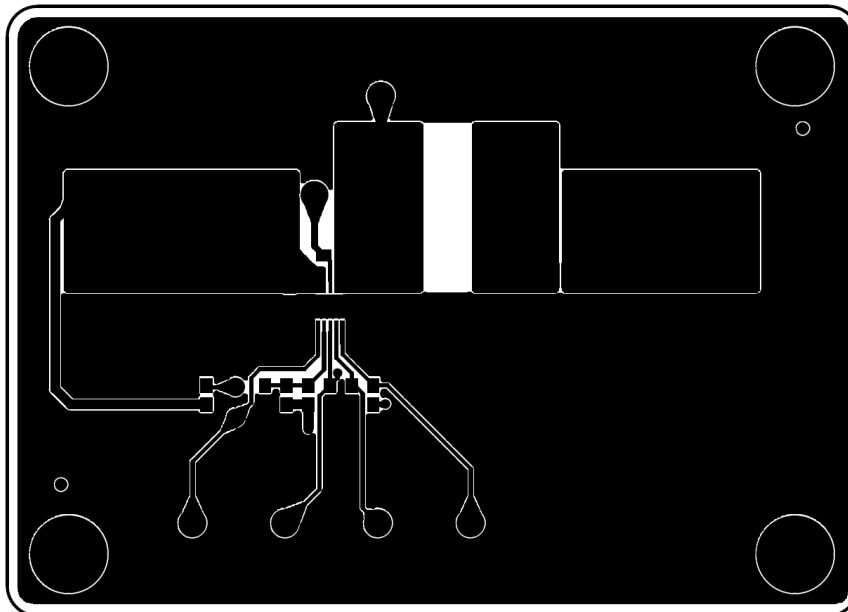

PCB Layout—Component Side (1st Layer)

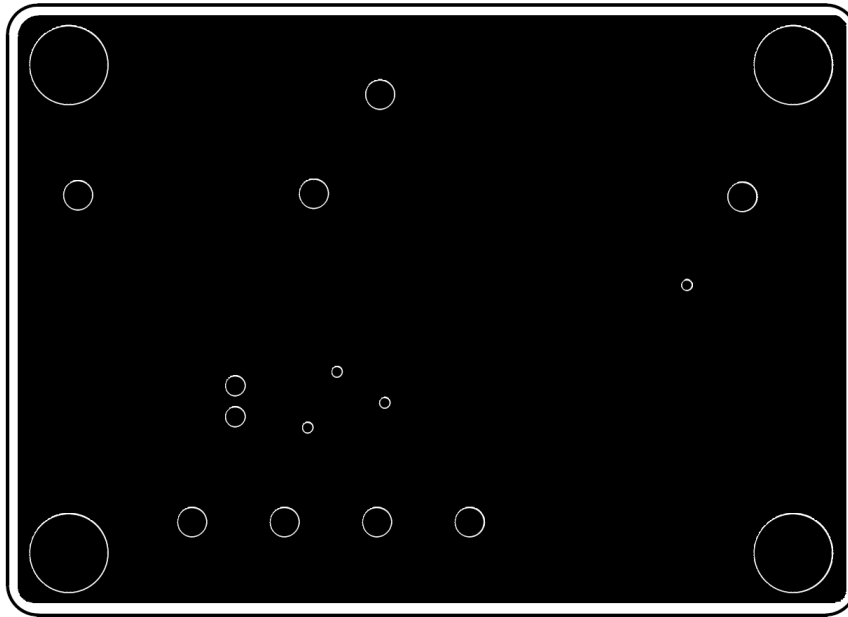

PCB Layout—Inner Side (2nd Layer)

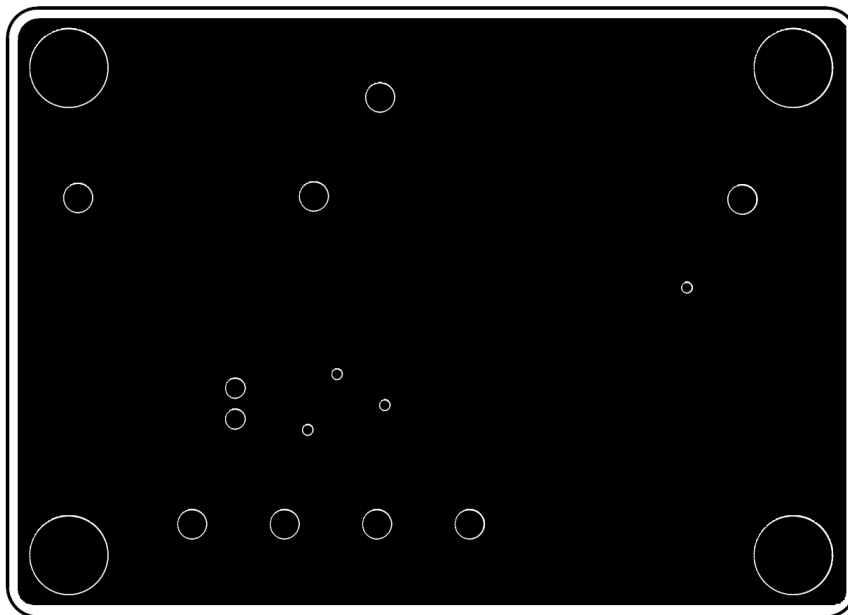

PCB Layout—Inner Side (3rd Layer)

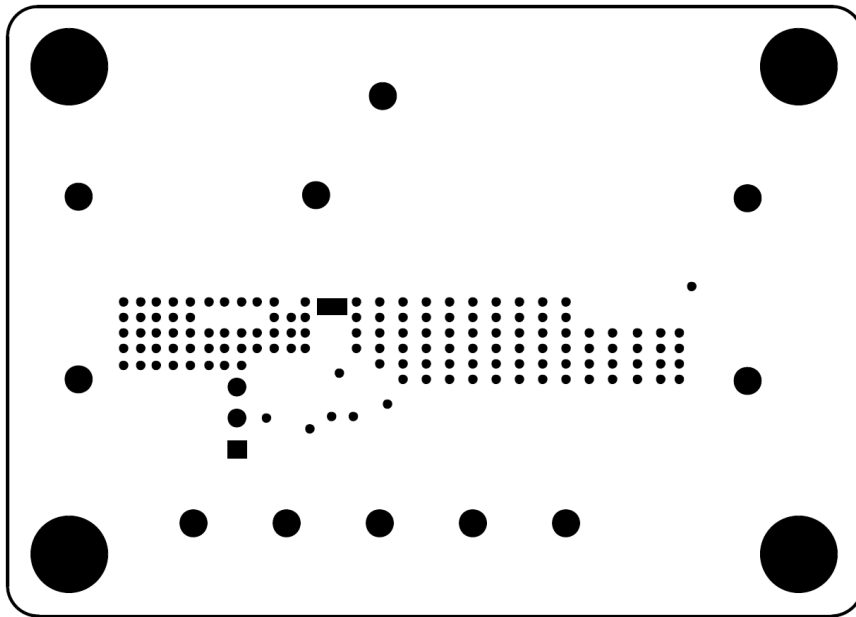

Component Placement Guide—Bottom Side (4th Layer)

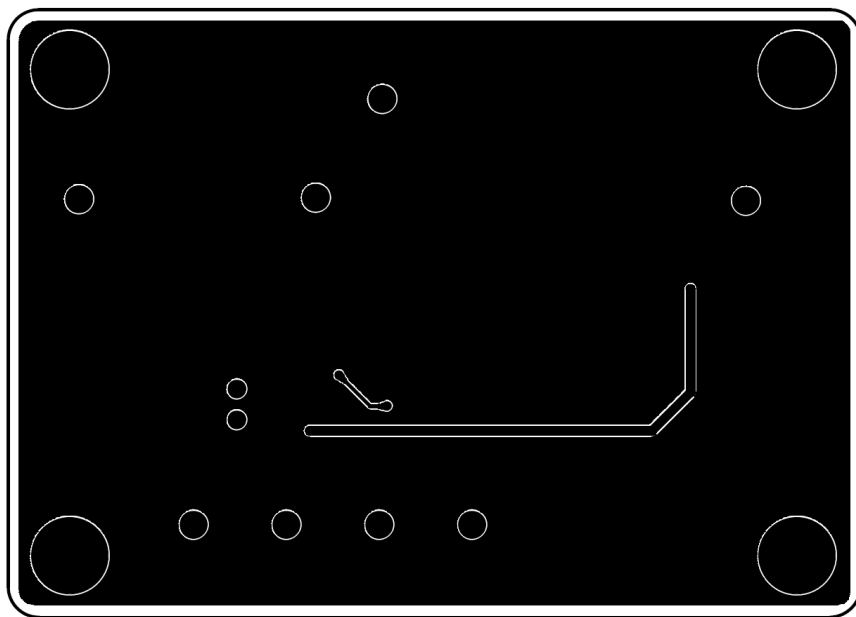

PCB Layout—Bottom Side (4th layer)

More Information

For more information, please find the related datasheet or application notes from Richtek website <http://www.richtek.com>.

Important Notice for Richtek Evaluation Board

THIS DOCUMENT IS FOR REFERENCE ONLY, NOTHING CONTAINED IN THIS DOCUMENT SHALL BE CONSTRUED AS RICHTEK'S WARRANTY, EXPRESS OR IMPLIED, UNDER CONTRACT, TORT OR STATUTORY, WITH RESPECT TO THE PRESENTATION HEREIN. IN NO EVENT SHALL RICHTEK BE LIABLE TO BUYER OR USER FOR ANY AND ALL DAMAGES INCLUDING WITHOUT LIMITATION TO DIRECT, INDIRECT, SPECIAL, PUNITIVE OR CONSEQUENTIAL DAMAGES.